

# SIMES

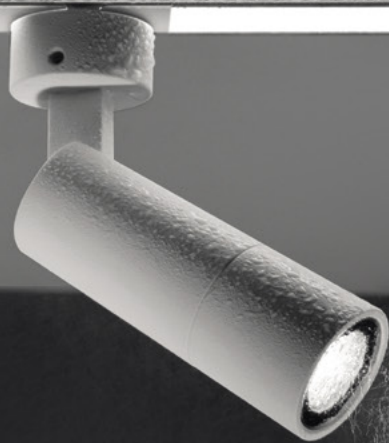

IP System™  
IP65 plug-in linear lighting system

The plug-in  
in humid environments  
is now possible.



Spa and  
wellness  
centers

Porches,  
patio and roof  
gardens

Wineries

...and also  
for interiors  
in general

**IP System** is the first IP65 dual power linear light system. It's composed of a light rod that besides being a stand-alone lighting fixture for diffuse lighting, it can also host and power at any point, one or more additional plug-in lights IP65.

Traditional light systems, characterized by an electrified track and a series of fixtures that can be positioned and powered from the track itself, are not usable in all those humid environments that require an adequate degree of protection.

**IP System**, with its innovative plug-in installation system IP65, provides a high degree of protection on all elements of the system and provides a flexible illumination of any space that requires effects of diffuse linear light combined with accent lighting effects. Its elegance and aesthetic simplicity makes it also suitable for any indoor environment.

**Mechanical installation  
and IP65 electrical plug-in**

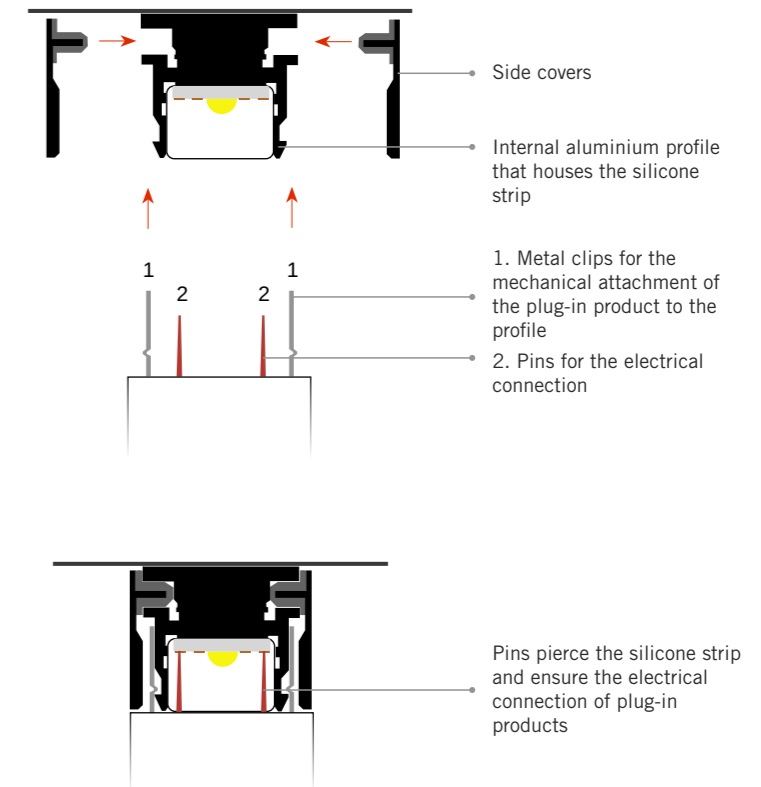

# Outdoor bright scenes

“**IP System** enriches the outdoor lighting project with new expressive potential. It allows to build flexible scenarios and to illuminate the subjects of the scene in changing spatial combinations.”

# Wide application solutions

**IP System** opens the way to the first generation of linear lighting systems for outdoor, and it does so with a wide variety of possibility.

A series of plug-in products with different features and functions connect to the Highlighter light rod. The Flower plug-in adjustable projectors, in 3 variants, can direct the beam in any direction enhancing the chosen subject. Trendy plug-in and Ceiling plug-in downlights have fixed optics and create defined accent effects from top to bottom. All elements of the system are available in black and white. The internal profile of Highlighter is always in black anodized aluminum.



FLOWER 35 plug-in



TRENDY plug-in



FLOWER ZOOM 60 plug-in

FLOWER 35 WITH ARM plug-in

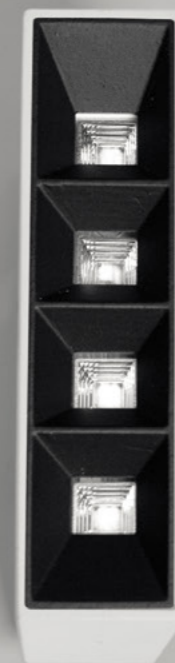

CEILING plug-in



HIGHLIGHTER

# Electrical installation IP65 plug-in

IP System has been patented for its special electrical IP65 connection that allows the installation of plug-in products anywhere in the system and their possible repositioning.

(This operation shall be managed by trained and qualified staff)



FLOWER 35 plug-in

FLOWER 35 WITH ARM plug-in

FLOWER ZOOM 60 plug-in

TRENDY plug-in

CEILING plug-in

The mechanical and electrical connection of all plug-in products to the light rod is via a double installation process:

- The two **metal clips** hook the black anodised aluminium profile externally and permanently ensure the product plug-in to the light rod;
- The **4 pins**, necessary for the 24V electrical connection, pierce the silicone strip housed in the profile and intercept a dedicated line that has an independent power line from the rod itself.

The **painted aluminium side covers** complete the fixture by hiding the fastening clips external to the profile. **The end caps** create an aesthetic and functional closure as they become an additional safety element for the joining of the components.



CEILING plug-in

TRENDY plug-in

FLOWER 35 plug-in

FLOWER ZOOM 60 plug-in

FLOWER 35 WITH ARM plug-in

Diffuse and  
accent light in a  
single solution

**The continuous and diffuse light effect of Highlighter, combined with a complete range of fixed and directional luminaires, offers a wide range of lighting possibilities.**

While the Highlighter light rod illuminates evenly and widely, creating a light base that can meet more functional requirements, plug-in luminaires can add light accents to the desired spots and can be distinguished in different types.

On the left page the downlights Ceiling plug-in and Trendy plug-in have fixed and comfortable optics and direct their beam exclusively downwards. They differ in aesthetics and power but perform the same function. On the right page we find the projectors with adjustable optics of the Flower plug-in family. Specifically, Flower 35, Flower 60 ZOOM and Flower 35 with arm, can tilt the beam in any direction, ideal for accent lighting producing defined and emotional effects.

**The overall consumption of the plug-in fixtures on each Highlighter Rod (regardless of its length 1, 2 or 3m) must not exceed 50W.**





**HIGHLIGHTER**

Light Rod IP65

HIGHLIGHTER is a light rod of 1, 2 or 3m in length composed of an IP65 LED source in opal silicone and a thin black anodized aluminium profile easily fixable to ceiling or wall. Inside the silicone strip are two independent power lines, one to feed the lighting rod and the other to feed the plug-in accessories.

**CEILING plug-in**

Linear downlight with fix optic IP65

CEILING is a linear downlight that thanks to its rearward optics, guarantees a total absence of glare and an excellent distribution of the beam on the ground. The glass is properly interposed between the internal reflectors and the external cowls for even more professional visual comfort. Available with 4 LEDs, CEILING plug-in is ideal for illuminating double height spaces or where a good even horizontal illumination is required.

**TRENDY plug-in**

Fix downlight IP65

TRENDY plug-in is a downlight with fixed comfortable optics consisting of 3 lenses and its cowls. Despite its reduced dimensions, it ensures excellent levels of lighting and visual comfort.

**FLOWER 35 plug-in**

Micro-tiltable projector with fixed optic IP65

FLOWER 35 plug-in is a micro-projector with IP65 comfortable directional optics engineered to be applied to the light rod HIGHLIGHTER. It offers high lighting performance while maintaining minimum dimensions. It's available with fixed optic 15° narrow beam, or with fixed optics 45° medium beam.

**FLOWER 35 WITH ARM plug-in**

Micro-tiltable projector with fixed optic IP65

FLOWER 35 WITH ARM plug-in has the same lighting characteristics of Flower 35 but with the addition of an arm that allows to easily reach even the most complex subjects.

**FLOWER ZOOM 60 plug-in**

Tiltable projector with adjustable optic IP65

FLOWER ZOOM 60 plug-in is a multi-focal projector with adjustable beam even when installed. The gradual adjustment that brings the beam from the concentrated SPOT 20° to the wide FLOOD 50° is always possible and takes place with a simple manual rotation of the front bezel.



**General lighting**

Highlighter ON and the plug-in products OFF



The lighting and dimming of the sole **Highlighter** rod, creates a uniform and diffused lighting suitable for, as example, to perform functional and work activities.

**Accent lighting**

Highlighter OFF and the plug-in products ON



The lighting and dimming of space-oriented **plug-in** products alone, creates a theatrical and emotional atmosphere that focuses on specific details.

**Accent lighting and general lighting**

Highlighter ON and plug-in products ON



The simultaneous lighting and dimming of **Highlighter** and **plug-in** products creates a balance between the two types of lighting and dampens the contrasts of light and shade produced by the plug-in luminaires.

# Separate lighting and dimming

The presence of two separate and independent power supply lines, one for the supply of the light rod (Highlighter) and the other specifically dedicated to the supply of the plug-in fixtures, allows the two different elements to be either switched or dimmed separately. It will then be possible to create different scenarios and vary them according to the applications. IP System therefore needs two separate power supplies both remote (dimmable or ON-OFF), one to control the light rod and one to power the plug-in products. The intensity of the light emitted may be modulated thanks to the possibility of wiring with dimmable 24V remote power supplies.

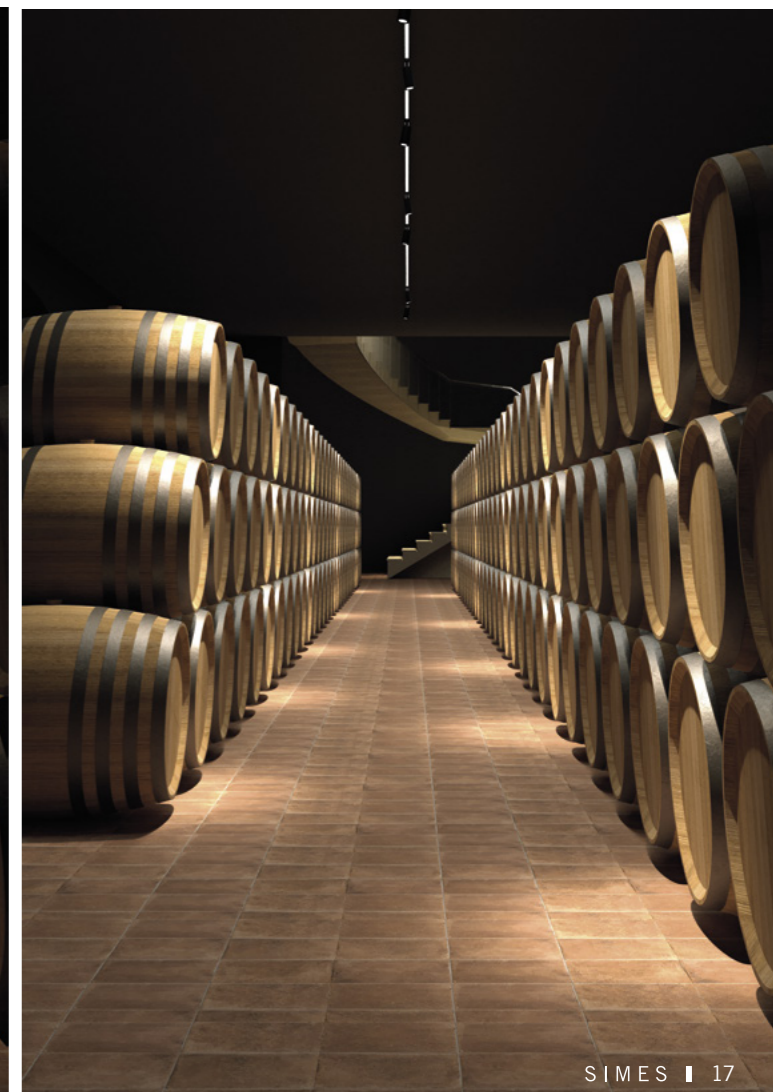
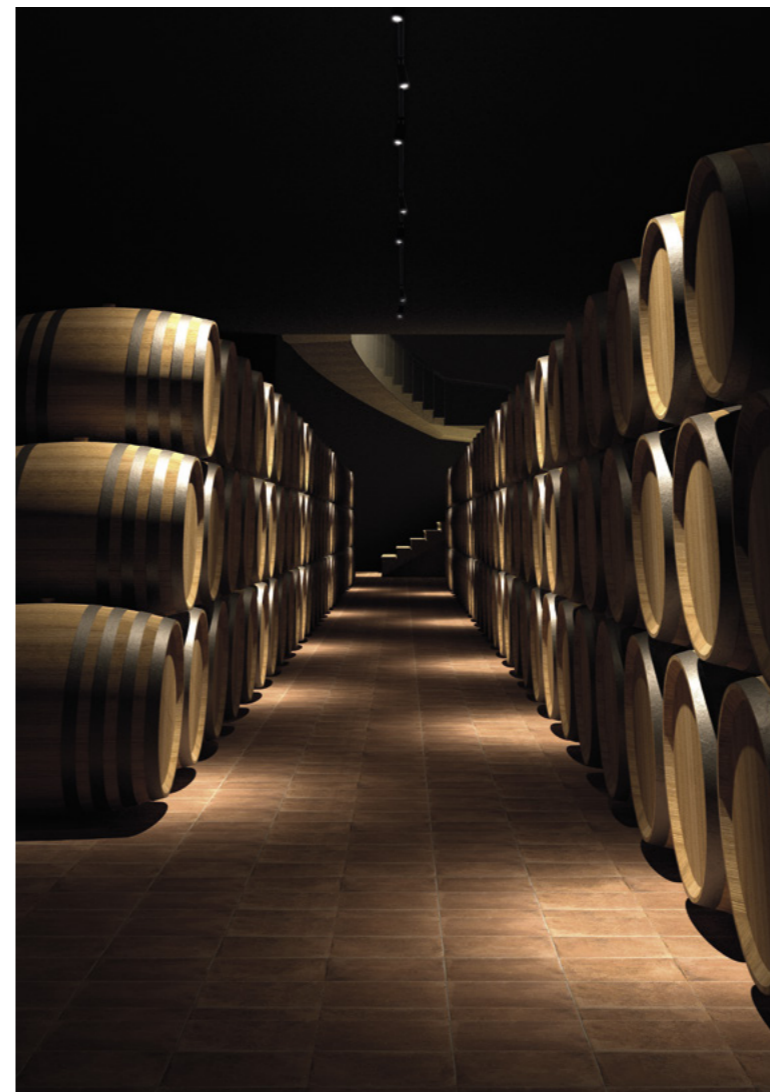



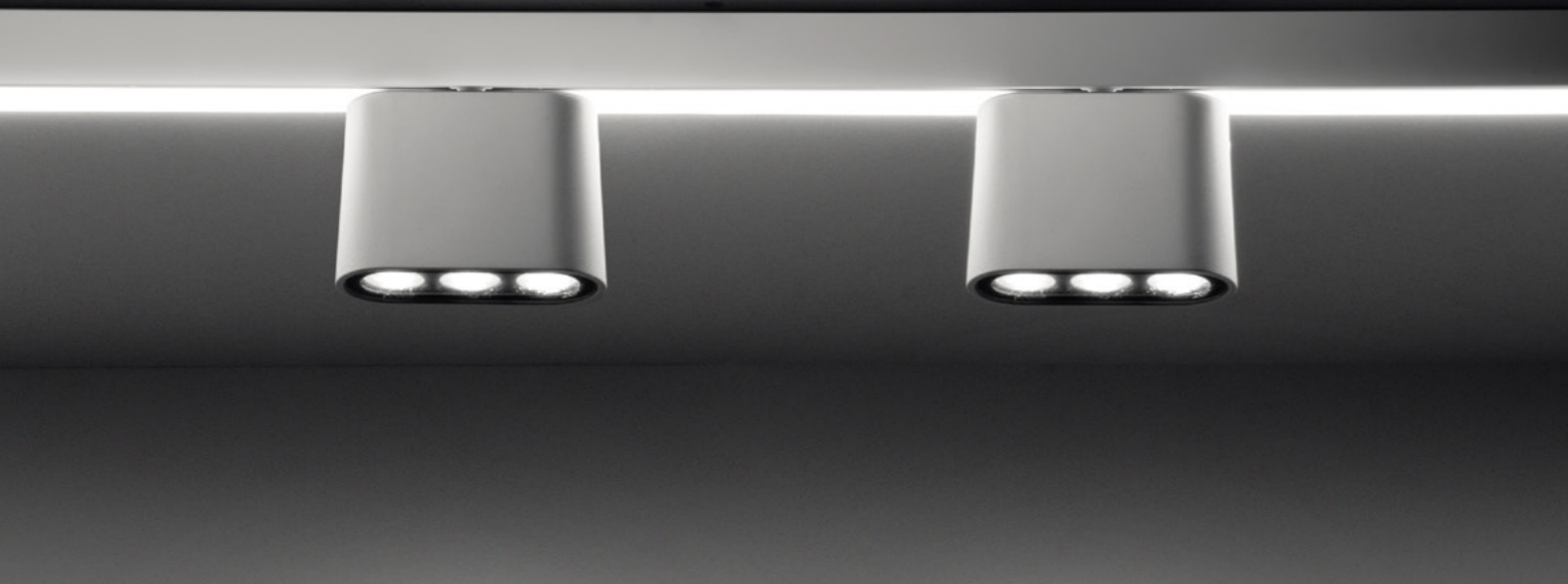

**Primary profile fixture**

**HIGHLIGHTER (light rod)**

Fixing base in black anodized extruded EN AW-6060 aluminium housing with high corrosion resistance 1, 2 or 3m length and side covers in painted aluminium. Luminaire hard wired with 5m single silicone 4-poles cable for two independent electrical circuits: one for the supply of the light rod and the other specifically dedicated to the supply of the plug-in fixtures. Continuous light source made of co-extruded opal silicone. AISI 301 painted end caps. **Double powder paint.**

Require constant voltage 24V DC remote power supply.

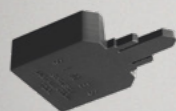

Installation template for plug-in fixtures included

**Additional plug-in fixture**

**FLOWER plug-in (adjustable projector)  
TRENDY plug-in (fixed downlight)  
CEILING plug-in (fixed downlight)**

Die-cast EN AB-47100 aluminium housing with high corrosion resistance. Clear toughened glass 4 mm thick. Comfort optic: clear lenses with the retracted position of the LED. No visible stainless steel screws. Fast clip-on fixation system and pins for the electrical connection. Silicone gaskets. Plug-in fixtures protected against the reverse polarity.

**Double powder paint.**  
Constant voltage 24V DC from the electrical connection to the HIGHLIGHTER lighting profile.

The overall consumption of the plug-in fixtures on each HIGHLIGHTER Rod (regardless of its length 1, 2 or 3m) must not exceed 50W.

Removal or replacement of the additional fixtures must be carried out by a qualified professional through the use of special tools.



Tool straightens pins included



Stabilizing clips included (only for Flower family and Trendy)

**Colors:**

.01 White

.09 Black

**IP rating**  
IP65

**Isolation**  
CLASS III

**Mechanical resistance**  
IK08 Highlighter  
IK07 Plug-in fixtures

Remote power supply 24V DC not included.

**PATENT PENDING  
REGISTERED DESIGN**

View the installation, removal and repositioning video instructions of the plug-in fittings and fill-up the assembly check-list leaflet.



[www.simes.it/en/tutorial/ipssystem](http://www.simes.it/en/tutorial/ipssystem)

**HIGHLIGHTER**

Light rod IP65

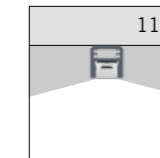

MID-POWER LED **3000K** CRI90 814lm / 1m  
Rated luminaire luminous flux 814lm / 1m  
Rated input power 14W / 1m **24V DC**  
Computer-simulated photometrics

Requires constant voltage remote power supply 24V DC

- S.9001W 1,0m
- S.9002W 2,0m
- S.9003W 3,0m

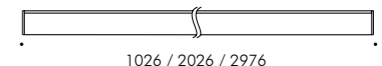

**TRENDY plug-in**

Fixed IP65 plug-in Downlight

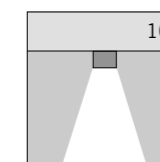
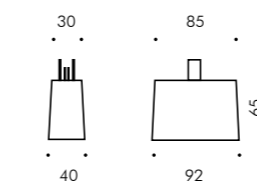

**S.9030W**  
3 HIGH-POWER LED **3000K** CRI90 450lm  
Rated luminaire luminous flux 355lm  
Rated input power 5,0W **24V DC**  
Computer-simulated photometrics

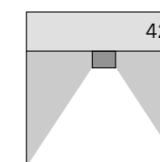

**S.9031W**  
3 HIGH-POWER LED **3000K** CRI90 450lm  
Rated luminaire luminous flux 355lm  
Rated input power 5,0W **24V DC**  
Computer-simulated photometrics

Constant voltage 24V DC from the electrical connection to the HIGHLIGHTER lighting profile.

**FLOWER 35 plug-in**

Adjustable IP65 plug-in Micro-Projector with fixed optic

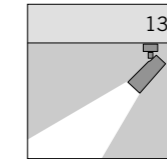
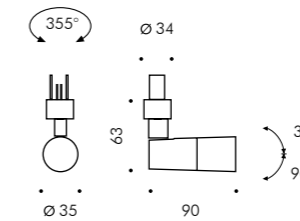

**S.9010W**  
1 HIGH-POWER LED 3000K CRI90 501lm  
Rated luminaire luminous flux 343lm  
Rated input power 7,0W **24V DC**  
Computer-simulated photometrics

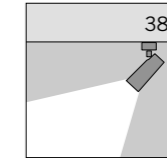

**S.9011W**  
1 HIGH-POWER LED 3000K CRI90 501lm  
Rated luminaire luminous flux 258lm  
Rated input power 7,0W **24V DC**  
Computer-simulated photometrics

Constant voltage 24V DC from the electrical connection to the HIGHLIGHTER lighting profile.

**FLOWER 35 WITH ARM plug-in**

Adjustable IP65 plug-in Micro-Projector with fixed optic

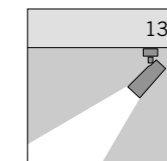
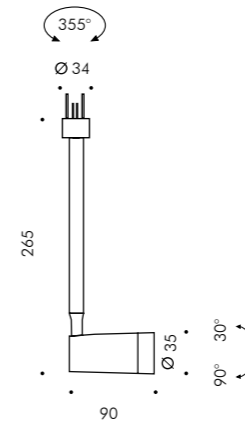

**S.9015W**  
1 HIGH-POWER LED 3000K CRI90 501lm  
Rated luminaire luminous flux 343lm  
Rated input power 7,0W **24V DC**  
Computer-simulated photometrics

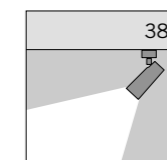

**S.9016W**  
1 HIGH-POWER LED 3000K CRI90 501lm  
Rated luminaire luminous flux 258lm  
Rated input power 7,0W **24V DC**  
Computer-simulated photometrics

Constant voltage 24V DC from the electrical connection to the HIGHLIGHTER lighting profile.

**FLOWER ZOOM 60 plug-in**

Adjustable IP65 plug-in Projector with adjustable optic

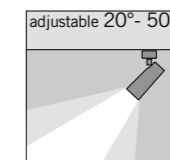
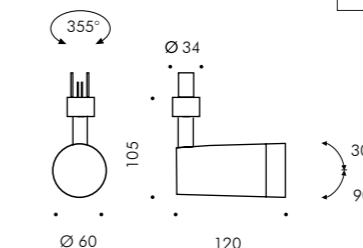

**S.9020W**  
1 HIGH-POWER LED 3000K CRI90 860lm  
Rated luminaire luminous flux 630lm  
Rated input power 9,0W **24V DC**  
Computer-simulated photometrics

Constant voltage 24V DC from the electrical connection to the HIGHLIGHTER lighting profile.

**CEILING 4 LED plug-in**

Fixed IP65 plug-in Downlight

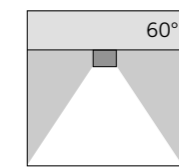
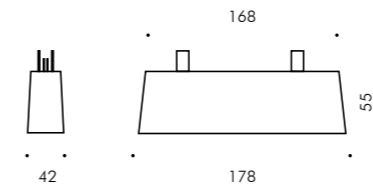

**S.9050W**

4 HIGH-POWER LED **3000K** CRI90 812lm  
Rated luminaire luminous flux 363lm  
Rated input power 10W **24V DC**  
Computer-simulated photometrics

**Constant voltage 24V DC** from the electrical connection to the **HIGHLIGHTER** lighting profile.





32  
SCHNEIDER

# SIMES

luce per l'architettura

**The present catalogue can not be reproduced even partially. All rights reserved.**

Due to continual luminaire development and improvement, any photographs, luminaire descriptions, measurements, illustrations, drawings and specifications in this catalogue may be approximations, and the company is not liable. We reserve the right to change specifications without prior notice.

For updated data, see technical sheets and installing instructions available on the website. Luminaires in this catalogue are REGISTERED and PATENT PENDING.



SIMES S.p.A. Via G. Pastore 2/4 - 25040 Corte Franca (BS) - ITALY  
Tel. (+39) 030 9860411 - Fax (+39) 030 9828308  
simes@simes.com - www.simes.com